

Starlight Mountains Quilt Pattern

Mountain Block

Unfinished Size - 16 1/2 x 16 1/2 inches

All seams are a scant 1/4 inch

Cutting Instructions for 6 blocks:

Color A (Navy) -

1 square: 5 1/4 x 5 1/4 in
18 squares: 4 1/2 x 4 1/2 in
4 squares: 2 7/8 x 2 7/8 in
2 rectangles: 2 1/2 x 4 1/2 in
28 squares: 2 1/2 x 2 1/2 in

Color B (Green) -

2 square: 5 1/4 x 5 1/4 in
8 squares: 2 7/8 x 2 7/8 in
12 rectangles: 2 1/2 x 6 1/2 in
4 rectangles: 2 1/2 x 4 1/2 in
44 squares: 2 1/2 x 2 1/2 in

Color C (White) -

1 square: 5 1/4 x 5 1/4 in
4 squares: 2 7/8 x 2 7/8 in
2 rectangles: 2 1/2 x 4 1/2 in
40 squares: 2 1/2 x 2 1/2 in

Color D (Light blue) -

2 squares: 5 1/4 x 5 1/4 in
12 squares: 4 1/2 x 4 1/2 in
8 squares: 2 7/8 x 2 7/8 in
12 rectangles: 2 1/2 x 6 1/2 in
4 rectangles: 2 1/2 x 4 1/2 in
32 squares: 2 1/2 x 2 1/2 in

1. We will be using the 4 at 1 time, no waste method to make some of our Flying Geese and we will make the rest with the 1 at a time method. You will be making 1 of each color combo:

- 1 Color A - 5 1/4 x 5 1/4 inch square and 4 Color B - 2 7/8 x 2 7/8 inch squares.
- 1 Color B - 5 1/4 x 5 1/4 inch square and 4 Color C - 2 7/8 x 2 7/8 inch squares.
- 1 Color B - 5 1/4 x 5 1/4 inch square and 4 Color D - 2 7/8 x 2 7/8 inch squares.
- 1 Color C - 5 1/4 x 5 1/4 inch square and 4 Color D - 2 7/8 x 2 7/8 inch squares.
- 1 Color D - 5 1/4 x 5 1/4 inch square and 4 Color A - 2 7/8 x 2 7/8 inch squares.
- 1 Color D - 5 1/4 x 5 1/4 inch square and 4 Color B - 2 7/8 x 2 7/8 inch squares.

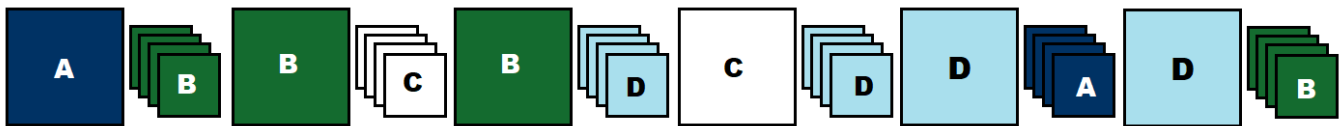

2. With right sides of fabric together, lay 2 small squares on opposite corners of the large square. Draw a diagonal line from the top corner to the bottom corner, on the back of the small squares. Pin in place. Sew a scant 1/4 inch seam on both sides of the drawn line. Cut on the center line. Press seam toward the small triangles.

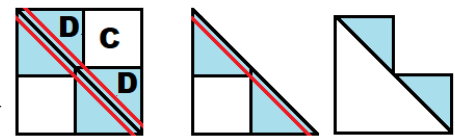

Black line is drawn line
Red line is sewn line

3. Lay 1 small square down on the corner, with right sides of fabric together. Draw a diagonal line from corner to corner, on the back of the small square. Sew a scant 1/4 inch seam on both sides of the drawn line.

Cut on the center line and press toward the small triangle. For best results, press with a dry iron.

Finished flying geese will measure: 2 1/2 x 4 1/2 inches.

Trim if needed. Set aside. You will have 4 flying geese of each color combo.

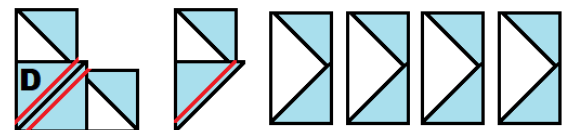

Mountain Block continued

4. We will be making the remaining flying geese using the 1 at a time method. Make 2 of each color combo:
 2 Color A - 2 1/2 x 4 1/2 inch rectangles and 4 Color B - 2 1/2 x 2 1/2 inch squares.
 2 Color B - 2 1/2 x 4 1/2 inch rectangles and 4 Color C - 2 1/2 x 2 1/2 inch squares.
 2 Color B - 2 1/2 x 4 1/2 inch rectangles and 4 Color D - 2 1/2 x 2 1/2 inch squares.
 2 Color C - 2 1/2 x 4 1/2 inch rectangles and 4 Color D - 2 1/2 x 2 1/2 inch squares.
 2 Color D - 2 1/2 x 4 1/2 inch rectangles and 4 Color A - 2 1/2 x 2 1/2 inch squares.
 2 Color D - 2 1/2 x 4 1/2 inch rectangles and 4 Color B - 2 1/2 x 2 1/2 inch squares.

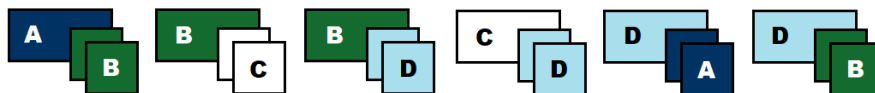

5. Take your rectangle, lay 1 square on top, lined up on the short edge, with right sides of fabric together. Draw a diagonal line from corner to corner, on the back of the small square. You will want to line your needle up on the outside of your drawn line when you are sewing. Stitch right next to the drawn line, toward the outside, see red line in diagram. Cut 1/4 inch from your sewn line as shown below. Press toward the attached triangle.



6. Place a square on the other side of the rectangle, with right sides of fabric together. Draw a diagonal line from corner to corner, on the back of the small square. You will want to line your needle up on the outside of your drawn line when you are sewing. Stitch right next to the drawn line, toward the outside of the line, see red line in diagram. Cut 1/4 inch away from this sewn line. Press toward the attached triangle.

Black line is drawn line
Red line is sewn line



These flying geese will measure: 2 1/2 x 4 1/2 inches. Trim if needed. Set aside.

7. Lay out 1 C/D, 1 B/C and 1 A/B flying geese. With right sides of fabric together, sew the three flying geese together to form a column, as shown. Press the seams up. **This unit will measure: 6 1/2 x 4 1/2 inches.** Trim if needed. **You will need 6 of these units.** Set aside.

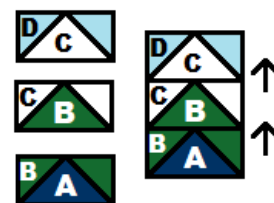

8. Lay out 1 Color A - 4 1/2 x 4 1/2 inch square and 1 D/A flying geese. With right sides of fabric together, sew together to form a column, as shown. Press the seam up. **This unit will measure: 6 1/2 x 4 1/2 inches.** Trim if needed. **You will need 6 of these units.** Set aside.

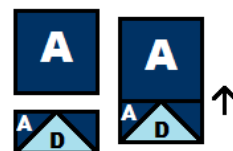

9. Lay out 1 B/D and 1 D/B flying geese. With right sides of fabric together, sew together as shown. Press the seam up. **This unit will measure: 4 1/2 x 4 1/2 inches.** Trim if needed. **You will need 6 of these units.** Set aside.

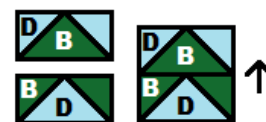

10. Lay out 2 Color D, 2 Color C and 1 Color B - 2 1/2 x 2 1/2 inch squares. Sew them together to form two separate rows, as shown. **They will measure: 2 1/2 x 6 1/2 inches and 2 1/2 x 4 1/2 inches.** Trim if needed. **You will need 12 of each combo.**

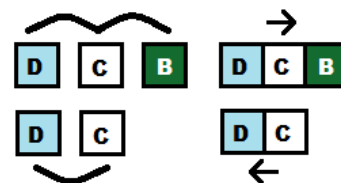

Mountain Block continued

11. Take the strips you made in step 10 and 1 Color D - 4 1/2 x 4 1/2 inch square. Lay them out as shown below. With right sides of fabric together, sew the D/C unit to the right side of the Color D square. Press the seam toward the Color D square.

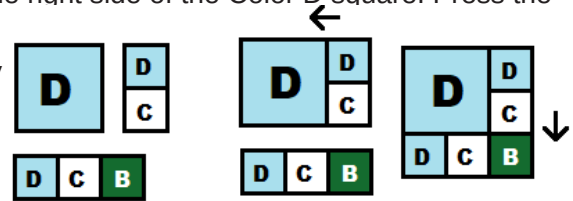

Next, with right sides of fabric together, nest the seams so they interlock, pin in place and sew the D/C/B unit to the bottom. Press the seam toward the attached strip unit.

This unit will measure: 6 1/2 x 6 1/2 inches.

You will need 12 of these units. Set aside.

12. Lay out 2 Color A, 2 Color B and 1 Color C - 2 1/2 x 2 1/2 inch squares. Sew them together to form two separate rows, as shown.

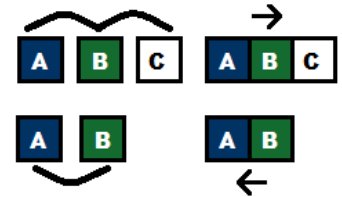

They will measure: 2 1/2 x 6 1/2 inches and 2 1/2 x 4 1/2 inches.

Trim if needed. **You will need 12 of each combo.**

13. Take the strips you made in step 12 and 1 Color A - 4 1/2 x 4 1/2 inch square. Lay them out as shown below. With right sides of fabric together, sew the B/A unit to the right side of the Color A square. Press the seam toward the Color A square.

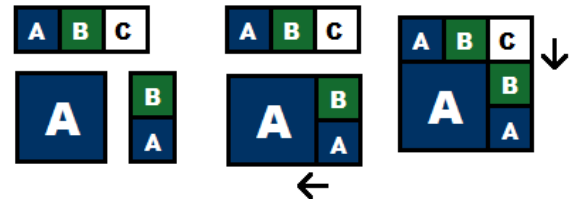

Next, with right sides of fabric together, nest the seams so they interlock, pin in place and sew the A/B/C unit to the top. Press the seam toward the attached strip unit.

This unit will measure: 6 1/2 x 6 1/2 inches.

You will need 12 of these units. Set aside.

14. With right sides together, sew 1 Color D and 1 Color B - 2 1/2 x 6 1/2 inch rectangle together, as shown. Press toward the Color B rectangle. **This unit will measure: 4 1/2 x 6 1/2 inches.** Trim if needed. **You will need 12 of these units.**

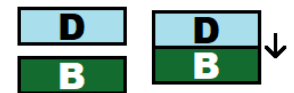

15. Lay out the units you made in the previous steps, as shown below. With right sides of fabric together, nest the seams so they interlock. Pin in place and sew together so they form 3 rows. Press the rows in alternating directions.

Next, with right sides of fabric together, nest the seams so they interlock. Pin in place and sew the three rows together to form the block. Press 4 blocks in one direction and remaining 2 blocks in the opposite direction, so they will nest together when you sew your final row. **This block will measure 16 1/2 x 16 1/2 inches.**

Trim if needed.

You will need 6 of these blocks.

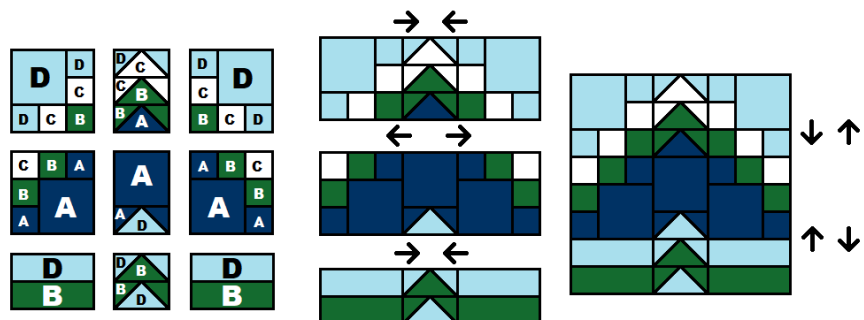

#NQCBlockChallenge
#HappyCloudCreations

Starlight Mountains Quilt Pattern

Pattern is for one person use. Please do NOT Copy, Sell or Distribute this Pattern without consent.
Pattern design by Andrea Smith of HappyCloudCreations.com Copyright 2020

Mountain Block
Page 3

Starlight Mountains Quilt Pattern by Andrea Smith of Happy Cloud Creations

Mountain Block Color Your Own!

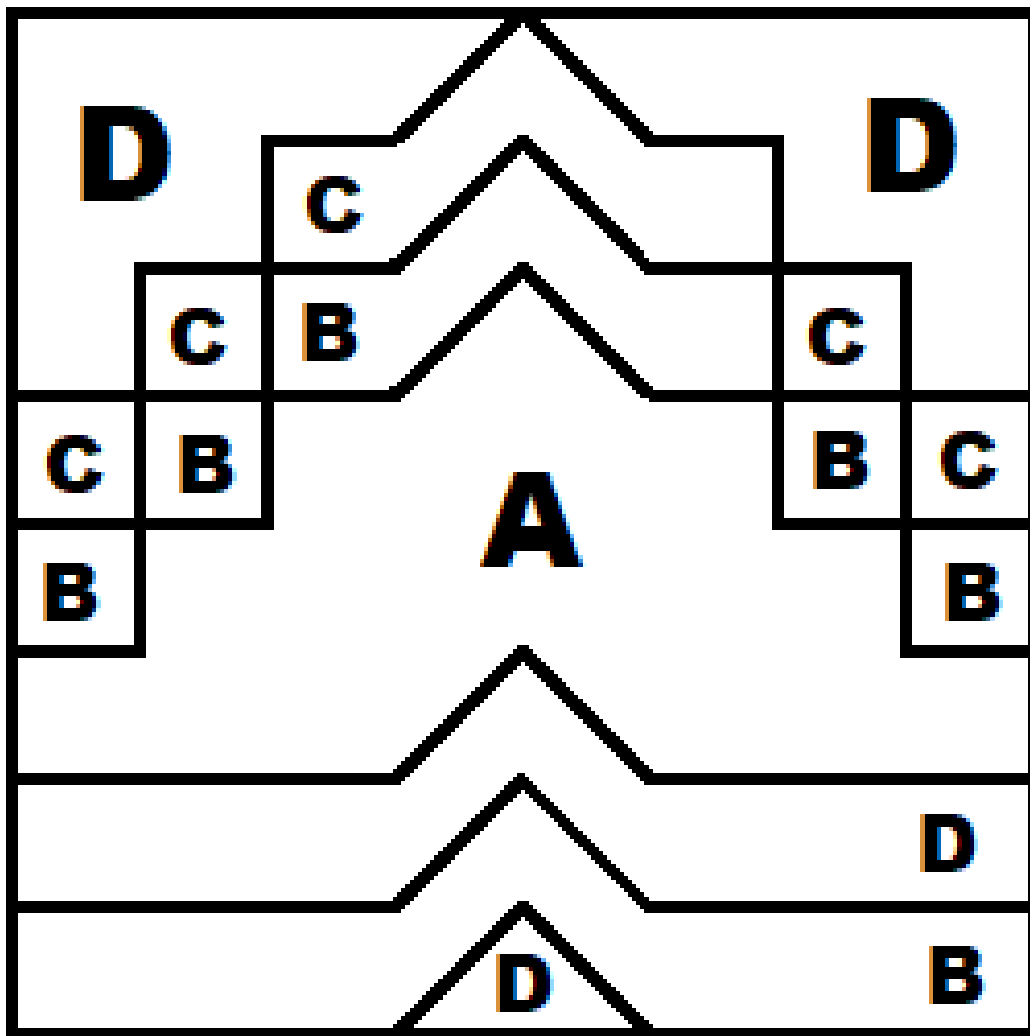

#NQCBlockChallenge
#HappyCloudCreations